

MDS

Modular Drive System

The Modular Drive System, MDS, is a powerful and cost-effective solution for applications with multiple axes. The MDS employs a unique backplane architecture that provides a common bus platform for one of three sizes of power modules and up to eight drive modules. The same MDS modules can operate on a 230V or 460V AC input. Plus, there are five different sizes of drive modules to meet the needs of almost any multiple axis application.

FM control modules, also used in our EN series drives, can be snapped to the front of an MDS drive module to extend drive functionality to the level required by the application. Ethernet, DeviceNet and Profibus FM controls are available for fieldbus communications.

NEW ANALOG POSITION MODE

In Analog Position Mode the drive moves to an absolute motor position in proportion to the voltage (± 10 VDC) received in the Analog Input. **Note:** Analog full scale voltage and position are programmable.

- 200 to 525 VAC, 3Ø input
- Up to 750 lb-in continuous torque
- True Common Bus Architecture
 - Reduced Part Count and Install Cost
 - Innovative backplane makes installing multiple drives quick and easy
- Easy install, setup and operate
 - Pluggable connectors, Standard D-Shell and Screw Terminals
 - State-Space Observer Control, which allows 10:1 inertia mismatch out of the box, and 50:1 with tuning
 - Free PowerTools software, and upgrades
- Accepts FM control modules for positioning control and enhanced programming capabilities
- Programmable, optically-isolated I/O
- Field programmable flash memory firmware, upgrades are free
- Auto-Tune support for any servo motor with encoder feedback



MDS Series



INNOVATIVE BACKPLANE

The MDS backplane provides a single AC input for the Power Module, and distributed DC bus and Logic Power for the Drive Modules. Installation time is minimized because the DC bus and Logic Power lines are an integral part of the backplane, so no extra wiring is needed. Fuses come installed on the backplane. Other than connecting motors, the installation is completed when the backplane is mounted on the panel and the power and drive modules are snapped into place and tightened down with a screwdriver.

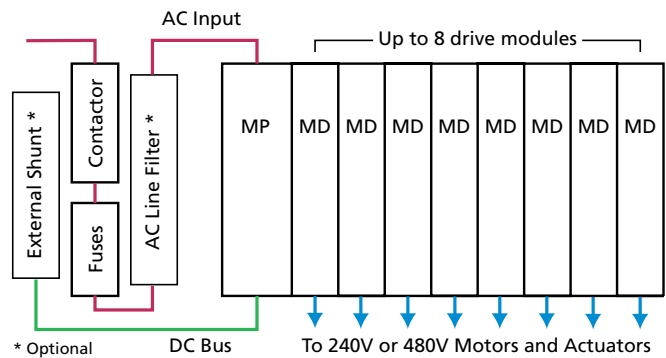

A very compact installation is possible because the backplane allows drives to be mounted directly next to one another. The use of a single, common power supply for multiple drives also minimizes installation space, and reduces cost, because with an MDS there is only one AC Input, one AC Contactor, one set of AC Fuses, and one AC Line Filter.

MODBUS **MODBUS TCP/IP**

POWER MODULE

MDS is a true common bus system. A single Power Module provides the AC rectification and generates DC bus power for the Drive Modules. This eliminates the problems associated with “pseudo” common bus systems, where each drive has its own power supply. MDS doesn’t have power-up conflicts.

Bus inductance is minimized with the use of bus bars, and by having a compact installation. Applications with quick deceleration and/or large loads are easily handled by an integrated microprocessor-controlled shunt transistor, which can be connected to an external resistor to dissipate regenerative energy. For emergency stops, the system can quickly be de-energized via an input that allows the user to instantly activate the shunt transistor. MDS allows for true power supply optimization.

Power Modules are available in three ratings and are designed to accommodate the total, simultaneous demand of the axes. In other words, the sizing of the Power Module is based on the maximum continuous and peak loads of the application at a given time—not the sum of the maximum drive power ratings, as rarely are all axes operating simultaneously or at peak power.

DRIVE MODULE

Five different-sized drive modules are available to provide a full range of performance-matched solutions for a variety of applications, whether needing high acceleration and cycle rates, or heavy torque and load handling capacity (up to 750 lb-in cont. torque). Like all of our “Motion Made Easy” drives, the MDS Drive Modules utilize our “State-Space” control, which enables drives to operate with a 10-to-1 inertia mismatch right out of the box, and up to a 50-to-1 inertia mismatch with optimization.

The MDS Drive Modules can operate in any of three modes: Velocity, Torque or Pulse. In the Velocity Mode the Drive Modules can run in Analog, Preset Velocity or Summation Sub-Modes. The Pulse Mode is able to interpret the signals as Pulse/Pulse, Pulse/Direction or Pulse/Quadrature from either Differential or Single-Ended outputs.

For a “Motion Made Easy” solution, our MDS Drive Modules accept the same FM control modules as our EN Series drives. These modules extend control capability of the base drives for advanced applications such as conveyor synchronization and high-speed labeling.

FM MODULES

FM control modules provide MDS Drive Modules with “snap on” functionality for indexing (FM-2), programming (FM-3), and advanced programming (FM-4) applications. The modular approach allows users to choose the level of advanced machine control they need, based on application parameters, not the drive “spec”. Because these sophisticated “snap-on” controls are not built into the drive, users can stock drives and not costly controls.

EASY INSTALLATION

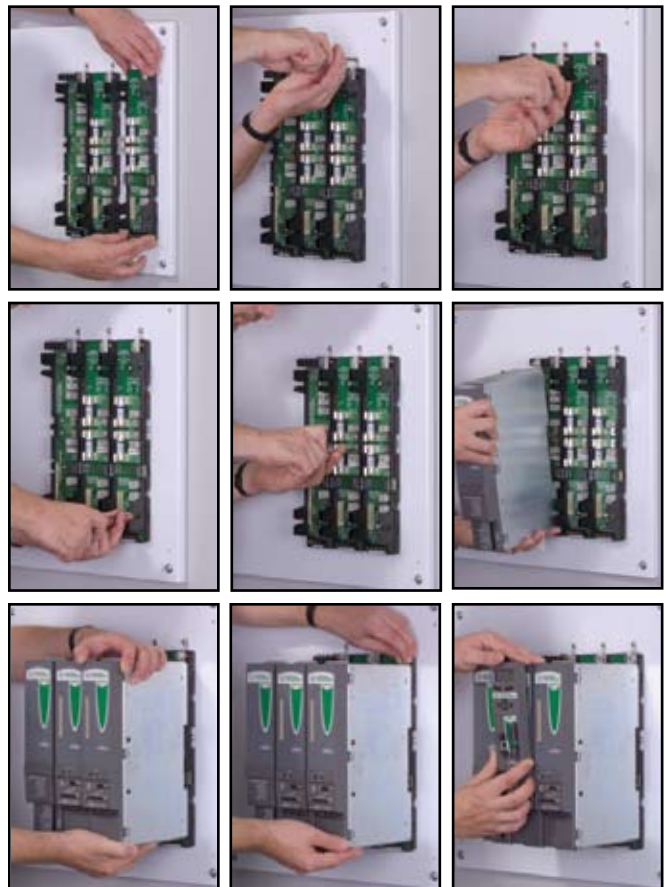

MDS installation is a snap.

The backplanes of the drive and power modules snap together and are mounted to the panel with screws. The drives are also grounded with screws. After tightening the bus bar screws, the modules are snapped into place and secured. Wiring is limited to a single AC power connection and wiring the motors to the drives. An external shunt resistor connection is also provided. Advanced control capability is provided by adding FM control modules to the system.

MDS

Base Drive Operation

The MDS drives can be easily implemented with single and multi-axis controllers, PLCs and host controllers for medium power applications. The analog torque or velocity modes can be used with classic position controllers using analog outputs and encoder inputs. The pulse mode is ideal for use with low-cost PLC stepper controllers. This drive works in a variety of applications where a host control provides a command signal determining the desired motion profile.

The drive is configurable for eight flexible modes of operation, and the parameters for each mode can be adjusted to tailor the drive to the specific application using Windows™-based PowerTools Pro software.

Position Tracker™ – Analog Mode

Analog Torque Mode

Analog Velocity Mode

Digital Velocity Preset

Pulse Mode

- Pulse/Pulse
- Pulse/Direction
- Pulse/Quadrature

Summation of Analog Velocity and Digital Velocity

- **Programmable I/O**
 - 5 optically-isolated inputs (1 dedicated)
 - 3 optically-isolated outputs
 - 1 analog input ± 10 VDC, 14-bit
 - 2 analog output ± 10 VDC, 10-bit
- **Programmable encoder output, (up to 8,192 lines per revolution)**
- **Separate stop and travel limit decel ramps**
- **Torque, travel, following error and velocity limits**
- **8 user defined speed presets with individual accel/decel rates**
- **2 programmable torque level outputs**
- **In motion velocity output**
- **Software oscilloscope**



MDS Series

STANDARD CONTROL MODES

Analog Velocity/Torque Mode

- MC Controller $\xrightarrow{\pm 10 \text{ VDC}}$
- Position Controller $\xleftarrow{\text{Pulse}}$



Digital Velocity Preset

- PLC $\xrightarrow{\text{Digital I/O}}$
- User Logic $\xrightarrow{\text{Digital I/O}}$



Pulse Mode

- PLC $\xrightarrow{\text{Digital I/O}}$
- Master Axis $\xrightarrow{\text{Digital I/O}}$
- Synchronized Encoder $\xrightarrow{\text{Pulse}}$



Summation of Analog Velocity and Digital Velocity

- PLC $\xrightarrow{\text{Digital I/O}}$
- User Logic $\xrightarrow{\text{Digital I/O}}$
- Analog Trim $\xrightarrow{\pm 10 \text{ VDC}}$



Position Tracker™ – Analog Mode

- PLC $\xrightarrow{\pm 10 \text{ VDC}}$
- Analog Feedback $\xleftarrow{\pm 10 \text{ VDC}}$



The operating mode of the drive is simply selected with one click in the PowerTools Pro Setup view.

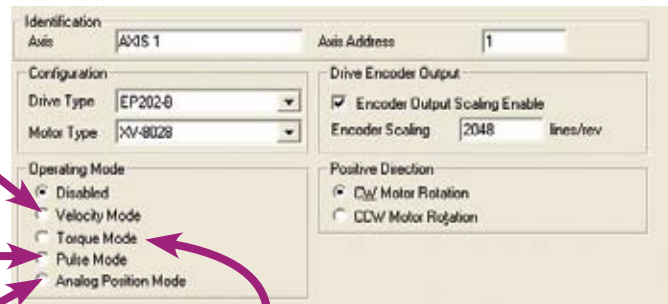

VELOCITY MODE

Analog— In Analog Velocity Mode the drive develops a velocity command in proportion to the voltage (± 10 VDC) received on the Analog Input. *Note: Analog full scale voltage and offset are programmable.*

Preset Velocity— In this mode one of up to eight digital velocities can be selected using the digital I/O or Modbus. Each preset has its own accel/decel ramps. No analog source is required!

Application Examples

- Clutch-brake replacement
- Phase control with a differential
- Automatic feed control
- Spindle speed control

Velocity Summation— This mode combines the features of Analog Velocity and Preset Velocity in one mode. It allows running a preset velocity and trimming it with an analog input, or vice versa, allowing advanced applications to be solved simply and elegantly without complex controllers.

Application Examples

- Loop/dancer arm control
- Phase advance/retard
- Speed trimming

PULSE MODE

In Pulse Mode the drive will receive pulses from a master source (single-ended or differential), which can be interpreted in three ways:

- Pulse/Pulse
- Pulse/Direction
- Pulse/Quadrature

Application Examples

- PLC pulse command outputs
- Electronic gearing
- Stepper drive replacement
- Web line ratio control

TORQUE MODE

In Analog Torque Mode the drive develops a torque command in proportion to the voltage (± 10 VDC) received in the Analog Input. *Note: Analog full scale voltage and offset are programmable.*

Application Examples

- With position/velocity controller
- Tension control

POSITION TRACKER™ ANALOG MODE

In this Analog Mode the drive moves to an absolute motor position in proportion to the voltage (± 10 VDC) received in the Analog Input. *Note: Analog full scale voltage and position are programmable.*

Application Examples

- Position Control with simple analog signal
- Replaces expensive PLC position control modules

FLEXIBLE I/O FUNCTIONALITY

The digital I/O of the drive is completely programmable with the ability to map one or more I/O functions to the I/O points.

Input Functions

- Stop
- Reset
- Travel Limit (+ and -)
- Torque Limit Enable
- Torque Mode Enable
- Velocity Presets (3)
- Brake Release
- Brake Control
- Enable Analog Position
- Teach Analog Position
- Define Analog Position

Output Functions

- Drive OK
- At Velocity
- Travel Limits (+ and -)
- In Motion (+ and -)
- Power Stage Enabled
- Torque Limit Active
- Velocity Limiting Active
- Fault
- Brake
- Shunt Active
- Torque Level 1 or 2 Active
- Foldback Active

MDS

With FM Modules

FM control modules (see FM Controls) provide MDS-MD drive modules with “snap-on” functionality for Indexing (FM-2), Programming (FM-3E), and Advanced Programming (FM-4E). This modular approach allows users to choose the level of advanced machine control they need, based on the applications parameters and not the drive “spec”.

Now programmed using the new PowerTools Pro software. It can also be used with PowerTools FM.

For applications requiring traditional multi-axis control, our MC controller is easily integrated with a single cable connection.



MDS Series

FM-2 INDEXING MODULE

The FM-2 module enhances EN drives by adding positioning capability including Jog, Home, Index functions including Position Tracker™ – Fieldbus Indexing. The FM-2 also includes additional I/O providing 8 digital inputs and 4 digital outputs.



- FM-2 Application Examples**
- Clutch-brake replacement
 - Extend-retract arm
 - Indexing table
 - Indexing conveyor

FM-4E ADVANCED PROGRAMMING MODULE

The FM-4E Advanced Programming module has taken all of the features and flexibility of the FM-3E, and added the ability to create complex motion profiles for sophisticated applications. The FM-4E adds versatility and extends functionality by including high speed data capture, summation of multiple motion profiles, program multi-tasking, and an array of parameters suitable for even the toughest applications. Profibus (FM-4PB) and DeviceNet (FM-4DN) options are also available.

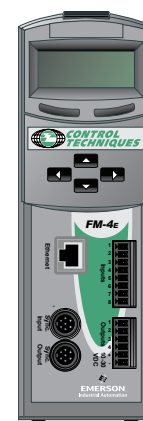

FM-3E PROGRAMMING MODULE

The FM-3E Ethernet module transforms the MDS into a fully programmable single-axis motion controller, and adds 8 digital inputs and 4 digital outputs. Profibus (FM-3PB) and DeviceNet (FM-3DN) options are also available.



- FM-3E Application Examples**
- Tension control
 - Flying cut off
 - Auger filler
 - Registration control
 - Slip compensation

- FM-4E Application Examples**
- Random infeed conveyor
 - Merge conveyor
 - Rotary knife
 - High speed labeling
 - Phase synchronization
 - Electronic gearing
 - Point-to-point positioning
 - Thermoforming
 - Web control

MDS TERMINALS AND PINOUTS

MDS Series

Power Module

Drive Module



AC Power	
Terminal	Signal
L1	AC Input
L2	AC Input
L3	AC Input
PE	PE

Digital I/O (J1)	
Pin Number	Signal
1	System Ready Output
2	Shunt Active Output
3	Shunt Fault Output
4	OverTemp Output
5	High VAC
6	Drive Module Fault Output
7	AC Interlock Relay
8	AC Interlock Relay
9	External Shunt Control
10	Fault Reset Input
11	Logic Supply +24VDC
12	Logic Supply 0V Common
13	PE
14	I/O Supply
15	I/O Supply 0V

DC Power	
Terminal	Signal
B+	DC Bus +
SHT	External Shunt Output
B-	DC Bus -

Digital I/O (J6)	
Pin Number	Signal
1	I/O Supply +
2	I/O Supply 0V
3	Drive Enable
4	Input 1
5	Input 2
6	Input 3
7	Input 4
8	Output 1
9	Output 2
10	Output 3

Motor Power	
Terminal	Signal
PE	PE
T	Motor Power T
S	Motor Power S
R	Motor Power R

Serial (J4)	
Pin Number	Signal
3	RS232 TX
2	RS232 RX
6	Serial +5VDC
5	Serial 0V Common
4	RS485+
9	RS485-
1	Shield
7,8	No Connect

Command (J5)	
Pin Number	Signal
15	Analog Command In +
14	Analog Command In -
8	Encoder Out A
9	Encoder Out A/
23	Encoder Out B
24	Encoder Out B/
37	Encoder Out Z
38	Encoder Out Z/
27	Pulse In A
41	Pulse In A/
26	Pulse In B
40	Pulse In B/
25	Pulse In Z
39	Pulse In Z/
20	Pulse In A (single ended)
36	Pulse In B (single ended)
16	I/O Input Drive Enable
1	I/O Input 1
2	I/O Input 2
3	I/O Input 3
4	I/O Input 4
19	I/O Output 1
18	I/O Output 2
17	I/O Output 3
33	I/O Supply +
34	I/O Supply +
31	I/O Supply 0V
32	I/O Supply 0V
29	Analog Out 0V
43	Analog Out Channel 1 +
44	Analog Out Channel 2 +
11	External Encoder +5VDC Power
12	External Encoder Common
28	+15V Power Out (10 mA)
6	RS485 +
21	RS485 -
5, 7, 10, 13, 22, 30, 35, 42	No Connect

Feedback (J7)	
Pin Number	Signal
1	Motor Encoder A
10	Motor Encoder A/
2	Motor Encoder B
11	Motor Encoder B/
3	Motor Encoder Z
12	Motor Encoder Z/
4	Motor Commutation U
13	Motor Commutation U/
5	Motor Commutation V
14	Motor Commutation V/
6	Motor Commutation W
15	Motor Commutation W/
7,8	Encoder +5 VDC Supply
17	Encoder 0V Common
9	Motor OverTemp
16,18-26	No Connect

Feedback Connector below not shown

MDS SPECIFICATIONS AND DIMENSIONS

Power Requirements

AC Input Voltage: 3Ø, 187 to 528 VAC, 47 - 63 Hz
(460 VAC for rated performance)

AC Input Current

MP-1250: 17 Arms (15A @ 100 ms soft start)
MP-2500: 35 Arms (15A @ 100 ms soft start)
MP-5000: 70 Arms (15A @ 100 ms soft start)

Output Continuous Current

MD-404: 4 Arms/2.8 Arms (5 kHz/10 kHz)
MD-407: 7 Arms/5 Arms
MD-410: 10 Arms/6.5 Arms
MD-420: 20 Arms/14 Arms
MD-434: 34 Arms/22 Arms
(Current ratings the same for 460V or 230V operation)

Output Peak Current

MD-404: 8A/5.6A (5 kHz/10 kHz)
MD-407: 14A/10A
MD-410: 20A/13A
MD-420: 40A/28A
MD-434: 68A/44A
(Current ratings the same for 460V or 230V operation)

Continuous Output Power

(Ratings based on 5 kHz, 460V/230V operation)
MP-1250: 12.5 kW/6.25 kW
MP-2500: 25 kW/12.5 kW
MP-5000: 50 kW/25.0 kW
MD-404: 3.3 kW/1.7 kW
MD-407: 5.8 kW/2.9 kW
MD-410: 8.3 kW/4.2 kW
MD-420: 16.7 kW/8.4 kW
MD-434: 28.3 kW/14.2 kW

Switching Frequency: 5 or 10 kHz

Logic Supply: +21.6 to 26.4 VDC,
(Required Accessory)

Encoder Supply Output: +5 VDC, 250 mA

System Efficiency: 90%

Regeneration

Internal Energy Absorption—System Bus Capacitance

Power Modules (460V/230V):

MP-1250: 110 Joules / 236 Joules
MP-2500: 183 Joules / 393 Joules
MP-5000: 293 Joules / 629 Joules

Drive Modules (460V/230V):

MD-404: 8 Joules / 17 Joules
MD-407: 17 Joules / 37 Joules
MD-410: 26 Joules / 55 Joules
MD-420: 37 Joules / 79 Joules
MD-434: 37 Joules / 79 Joules

Integral Transistor connected to an external resistor:

MP-1250: 30 Ohm minimum, 6 kW max
MP-2500: 30 Ohm minimum, 6 kW max
MP-5000: 9 Ohm minimum, 12 kW max

I/O Supply: +10 to 30 VDC

Power Module Control Inputs

Digital:(2) +10 to 30 VDC, 2.8 kOhm,
Sourcing, Optically Isolated

Power Module Control Outputs

Digital:(6) Digital: +10 to 30 VDC, 150 mA,
Sourcing, Optically isolated
Relay Contact:(1) AC Interlock, 24 VDC, 5A

Drive Module Control Inputs

Analog: (1) Analog: +/- 10 VDC 14 bit,
100 kOhm, Differential

Analog Max Input Rating: +/- 14 VDC, Differential
or Each Input with Reference to Analog Ground

Digital: (5) +10 to 30 VDC, 2.8 kOhm, Sourcing,
Optically isolated

Pulse: (1) Pulse, Differential: RS422, 2 MHz/
Channel, 50 % Duty Cycle (1) Pulse, Single
Ended: TTL Schmitt
Trigger

Drive Module Control Outputs

Analog: (2) +/- 10 VDC 10-bit, single ended, 20 mA

Digital: (3) +10 to 30 VDC, 150 mA, Sourcing,
Optically isolated

Motor OverTemperature: (1) 0 to +5 VDC, single
ended

Pulse: Differential: RS422 and TTL
compatible, 20 mA/Channel,
Sink or Source

Cooling Method

MP-1250: Convection
MP-2500: Integral Fan
MP-5000: Integral Fan
MD-404: Convection
MD-407: Integral Fan
MD-410: Integral Fan
MD-420: Integral Fan
MD-434: Integral Fan

Environmental

Rated Ambient Temperature: 32° to 104°F
(0° to 40°C)

Maximum Ambient Temperature: 32° to 122°F
(0° to 50°C) with power derating of 3.5% / 1.8°F
(1°C) above 104°F (40°C)

Rated Altitude: 3280' (1000 m)

Maximum Altitude: For altitudes >3280' (1000 m)
derate output by 1%/328' (100 m)

Vibration: 10 to 2000 Hz @ 2g

Humidity: 10 to 95% non-condensing

Storage Temperature: -13° to 167° (-25° to 75°C)

Ingress Protection: IP-20

Serial Interface

RS232/RS485 Modbus RTU - 9600 to 19.2 kBaud
Internal RS232 to RS485 Converter

Power Module Weight

MP-1250: 8.35 lb (3.78 kg)
MP-2500: 8.35 lb (3.78 kg)
MP-5000: 10.25 lb (4.65 kg)

Drive Module Weight

MD-404: 8.35 lb (3.78 kg)
MD-407: 8.35 lb (3.78 kg)
MD-410: 8.35 lb (3.78 kg)
MD-420: 10.25 lb (4.65 kg)
MD-434: 12.0 lb (5.44 kg)

Go to
Power CD
for complete data

MDS Dimensions

POWER MODULES – MP-5000 SHOWN

Go to
Power CD
for complete data

Power Module Model	Dimension A
MP-1250 & MP-2500	2.75 in. [69.85 mm]
MP-5000	3.50 in. [88.90 mm]

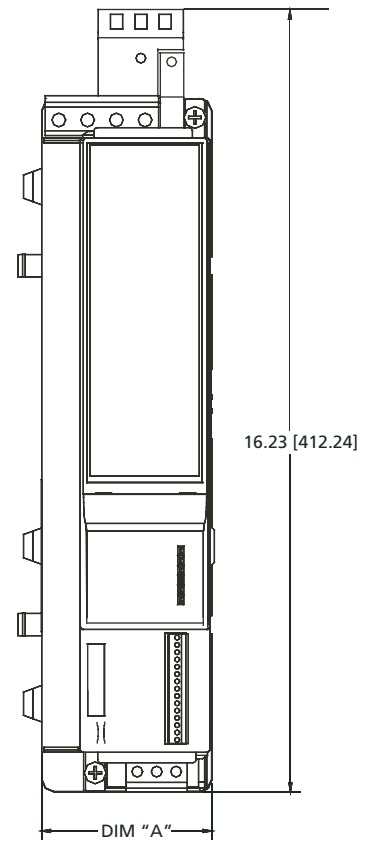
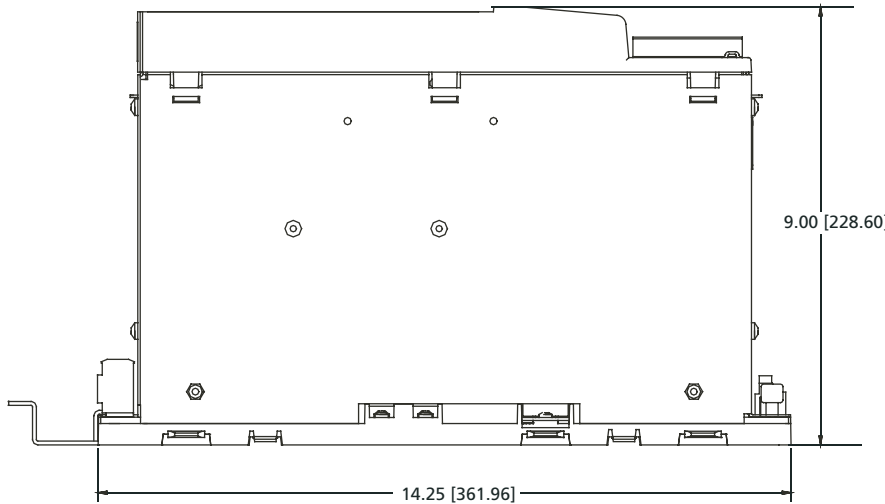

MDS Series

DRIVE MODULES – MD-420 Shown

Drive Module Model	Dimension A
MD-404, MD-407 & MD-410	2.75 [69.85]
MD-420	3.50 [88.90]
MD-434	5.49 [139.50]

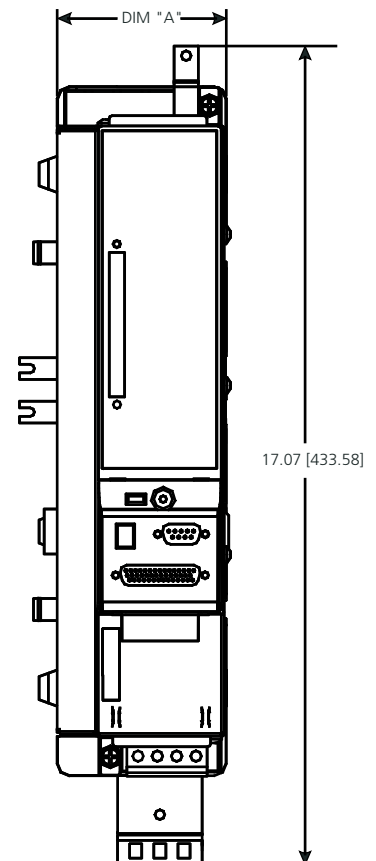
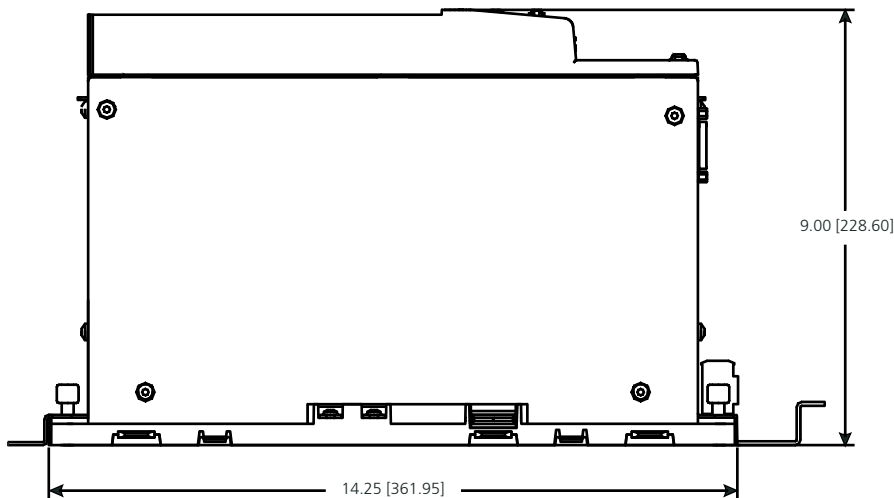

HOW TO ORDER

Depending on your motor selection, use one of the following drive to motor combination pages, to configure a basic MDS system by selecting one item from each of the four ordering columns, and the fifth column if you are choosing a brake motor. Note that item ② motor selection requires additional input as to flange, and on NT systems connector type. (See the Motor Order String boxes for details.) Items ③ through ⑤ require cable lengths to be provided. ⑥ After selecting each axis combination, a power module will need to be selected to complete the system. The basic systems represented on the following pages can be customized with a variety of components depending on your needs. A guide to Options and Accessories for MDS can be found on the next page, with details in the *Options and Accessories* section.

SELECT SYSTEM AND MOTOR

① Select the MDS Drive Module(s) appropriate to the needs of your application and operating environment, the 4-Amp MD-404, 7-Amp MD-407, 10-Amp MD-410, 20-Amp MD-420, or 34-Amp MD-434.

Note: The current rating for the drive module is the same whether 230V or 460V.

② Select the motor model appropriate to the drive module. (Note there are brake and non-brake models.)

CABLE ORDERING OPTIONS

Motor power, feedback and brake cables with MS style connectors are fully shielded with IP65 molded connectors and are available in standard and custom lengths. For more information on these and other cables, see *Options and Accessories* section.

Standard lengths of 5, 15, 25, 50 and 100 feet are available from stock. Non-standard lengths require additional lead time. **Note: Equivalent FM Motor cable lengths are in meters.**

Feet=xxx or meters=yyy with specified lengths. Example: 005 = 5 feet. For applications involving continuous flexing, flexible cables are available. Cable components such as connector kits and raw cable are also available. See Options section for details or consult factory for special requirements.

③ Motor Power Cables

Using the selection guide, choose the appropriate power cable for the motor.

④ Motor Feedback Cables

From this column, choose the appropriate feedback cable for the motor.

⑤ Motor Brake Cable

Choose a brake cable if a brake motor is selected.

⑥ Power Module Selection

After selecting all of the axis combinations (drive modules and motors), a power module needs to be selected. To select the proper power module, use the Total Axis Power Table below and add up the power (kW) for each axis to determine the system power required. Then, select the power module which has sufficient power.

Drive Module	Motor Model	Total Axis Power (kW)
MD-404	MG-316	0.9
	MH-316	1.0
	MH-340	1.6
	MH-455	2.1
	95U2B400	1.6
	95U2E400	2.5
MD-407	MG-316	1.0
	MG-340	1.8
	NT-320	1.0
	NT-330	1.6
	MH-455	2.2
	MH-490	2.2
	95U2E400	3.0
	115U2C300	4.4
	115U2E300	4.4
	142U2C300	4.4
MD-410	MG-455	2.2
	NT-345	2.0
	NT-355	2.4
	MH-490	2.2
	MH-6120	3.8
	115U2C300	3.2
	115U2E300	5.0
	142U2C300	4.8
	142U2E300	6.3
MD-420	MG-455	2.3
	MG-490	3.4
	MG-4120	5.0
	MH-6200	4.1
	MH-6300	4.5
	MH-8250	8.8
	142U2E300	7.1
	190U2D300	12.6
	190U2F200	12.6
MD-434	MH-8500	11.7
	MH-8750	16.5
	190U2D300	13.0
	190U2F200	13.2

Power Module	Input Power	
	3Ø 460V	3Ø 230V
MP-1250	12.5 kW	6.25 kW
MP-2500	25 kW	12.5 kW
MP-5000	50 kW	25 kW



REQUIRED ACCESSORY

The MDS requires an external logic supply to power the internal logic of the Power Module and Drive Modules. Use the table below to determine the current requirements of the application.

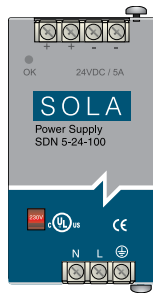

Module	Model Number	(A) RMS Current
Power Module	MP-1250	0.30
	MP-2500	
	MP-5000	
Drive Module	MD-404	0.60/Module
	MD-407	
	MD-410	
	MD-420	
	MD-434	0.80/Module
FM Module	All	0.40/FM Module
Synchronization Feedback Encoder	—	0.07/Encoder

Control Techniques offers the following 24 VDC logic-I/O power supplies:

MLP-002-00

2.1 Amp, +24 VDC, universal input 90 to 264 VAC.

MLP-005-00

5 Amp, +24 VDC, universal input 90 to 264 VAC.

MLP-010-00

10 Amp, +24 VDC, universal input 90 to 264 VAC.

OPTIONS AND ACCESSORIES FOR MDS

Control Techniques provides a complete array of options and accessories to complete your system. For details, see the *Options and Accessories* section of the catalog.

Brake Relays

BRM-1

Breakout Board

ECI-44, DEMO-FMIO-000, DEMO-DRIO-000

Diagnostics

DGNE

Logic Supplies

MLP-002-00, MLP-005-00, MLP-010-00

External Shunts/Resistors

(see Power Accessories)

AC Line Filters

MF-1250-20 (MP-1250), MF-2500-35 (MP-2500), MF-5000-65 (MP-5000)

AC Line Reactor

MLR-2580-00 (MP-5000)

Consult Factory for AC Line Reactors used on MP-1250 and MP-2500

Motor Power Filter

MPF-002-00, MPF-003-00

Synchronization Encoders

SCSLD-4, SCSLD-4R

Operator Interface

CTVue, OIT, CTIU

Extended Warranty

Extends Two Year Warranty to Five Years

MDS

230V FM Motor

The FM 230V line is a medium to high inertia line for larger load applications. It is designed to allow use in many applications and offers a wide range of options. The FM line is offered in metric frame sizes, 75 mm, 95 mm, 115 mm, 142 mm and 190 mm. The standard configured motor has a 4096 line encoder, vertical connectors and non-brake. This configuration is designed with low cogging torque to provide smooth operation and excellent velocity regulation. The torque range available is 19.0 lb-in (2.1 Nm) to 364 lb-in (40.1 Nm). All models are rated IP65.

The FM motor is also available with many other options like resolver and Sin/Cos feedback, NEMA flange, different shaft diameters, 90° and rotatable connectors, and a high peak torque option that allows intermittent operation near 5 times their continuous torque levels.



MDS - 230V FM Motor Specifications

Drive Model	Motor Model**	Cont. Stall Torque lb-in Nm	Peak Stall Torque lb-in Nm	Rated Torque @Rated Speed* lb-in Nm	Rated Power HP kWatts	Max.* Operating Speed RPM	Encoder Resolution lines/rev	Inertia lb-in-sec ² kg-cm ²	Motor Ke Vrms/ krpm	Motor Kt lb-in/Arms Nm/Arms	Motor Weight lb kg
MD-404	075E2B40	19.50	50.98	15.05	0.95	4000	4096	0.001	44	6.37	9.7
		2.23	5.76	1.70	0.71						
MD-404	075E2C40	25.49	50.98	20.36	1.28	4000	4096	0.001	44	6.37	11.4
		2.88	5.76	2.30	0.96						
MD-407	075E2D30	34.57	103.54	30.98	1.47	3000	4096	0.002	57	8.23	13.2
		3.91	11.70	3.50	1.10						
MD-407	095E2B40	38.13	89.21	26.55	1.68	4000	4096	0.003	44	6.37	13.9
		4.32	10.08	3.00	1.26						
MD-410	095E2D40	63.72	127.44	43.37	2.73	4000	4096	0.005	44	6.37	19.1
		7.20	14.40	4.90	2.05						
MD-410	115E2C30	82.31	164.61	71.69	3.39	3000	4096	0.008	57	8.23	25.5
		9.30	18.60	8.10	2.54						
MD-420	115E2E30	135.80	329.22	111.51	5.28	3000	4096	0.012	57	8.23	33.9
		15.35	37.20	12.60	3.96						
MD-420	142E2D30	164.61	329.22	107.97	6.61	3000	4096	0.024	57	8.23	41.6
		18.60	37.20	12.20	4.96						
MD-434	190E2D20	364.27	842.52	326.57	10.31	2000	4096	0.076	85	12.39	74.6
		41.16	95.20	36.90	7.73						

*Rated Speed = Maximum Operating Speed

**See the complete order string in the Servo motor section of this catalog.

MDS - 230V FM Motor Speed Torque Curves

MDS Series

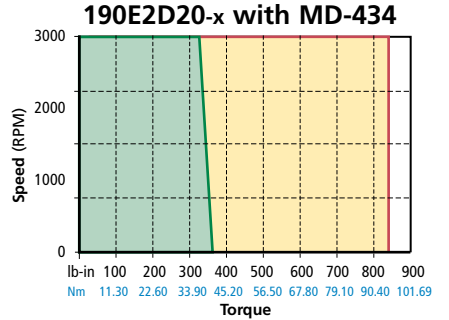
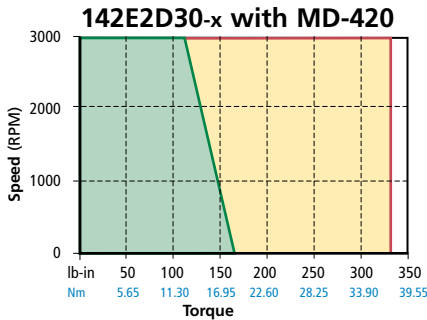
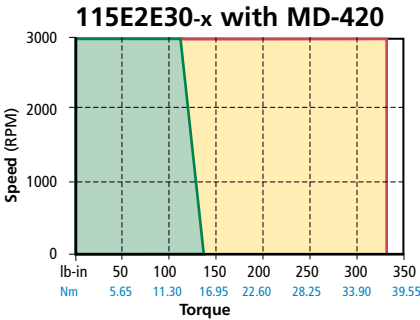
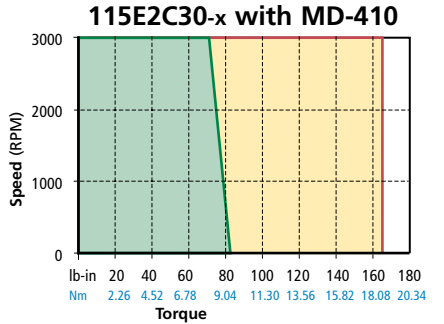
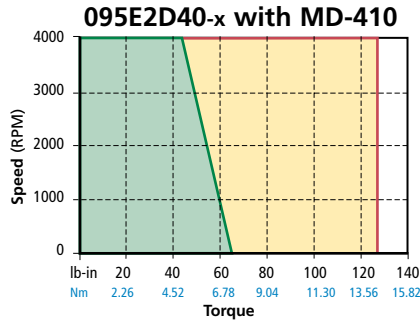
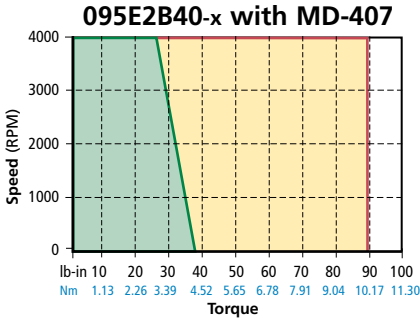
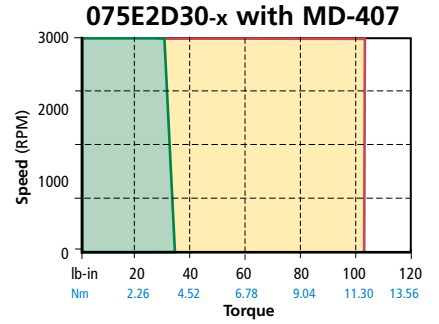
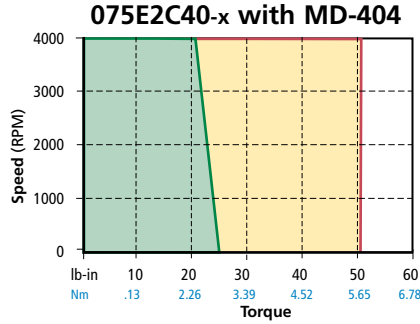
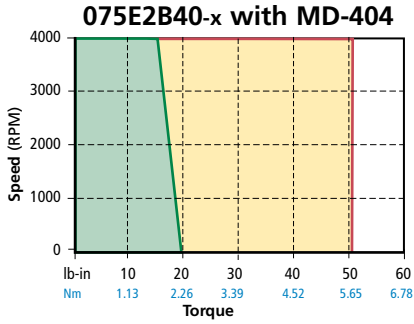

Legend

- Continuous Torque
- Peak Torque

SPECIFICATIONS

Voltage 240 VAC
 Drive Frequency 5 kHz
 Ambient Temperature 40°C (104°F)
 Case Temperature 140°C (284°F)

All performance data listed above has a +/-10% tolerance and is subject to change at any time without notice. For more detailed information on performance data and test conditions please refer to the motor section of the catalog. For brake motor information, complete motor specifications and dimensions please refer to our motor section.

MDS

230V FM Motor Selection

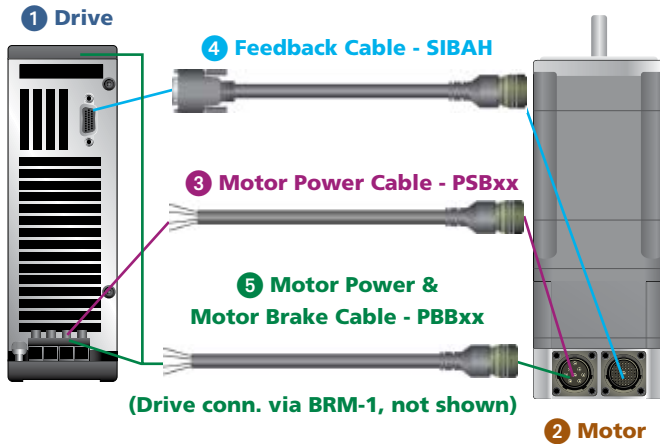

Order String

xxx	E	2	x	xx	x	B	A	CA	A	BCD*	DIA*
↑	↑	↑	↑	↑	↑	↑	↑	↑	↑	↑	↑

Inertia: A = Standard
 Feedback Device: CA = 4096 Incremental Encoder
 Shaft Key: A = With Key
 Connection Type: B = 90° Connectors
 Brake: 0 = None, 1 = 24 VDC
 Rated Speed: 20 = 2,000 rpm, 30 = 3,000 rpm, 40 = 4,000 rpm, 50 = 5,000 rpm
 Stator Length: A, B, C, D, E, F, G, H
 Peak Torque: 2 = Standard Peak Torque
 Voltage E = 230V
 Frame Size: 075, 095, 115, 142, 190

* Bolt Circle & Shaft Diameter are standard dimensions see FM Motor section for additional options.

For additional motor information see the Servo Motor area in this section for details.
For additional cable options see Options

MDS Series

Servo System Order Guide

① Drive Model	② Motor Model	③ Motor Power Cable (yyy=meters)	④ Feedback Cable (yyy=meters)	⑤ Motor Power/Brake Cable (required w/all brake motors) (yyy=meters)
MD-404	075E2B400 BACAA075140	PSBAA-yyy	SIBAH-yyy	PBBAA-yyy
	075E2B401 BACAA075140		SIBAH-yyy	
	075E2C400 BACAA075140	PSBAA-yyy	SIBAH-yyy	
	075E2C401 BACAA075140		SIBAH-yyy	PBBAA-yyy
MD-407	075E2D300 BACAA075140	PSBAA-yyy	SIBAH-yyy	
	075E2D301 BACAA075140		SIBAH-yyy	PBBAA-yyy
	095E2B400 BACAA100190	PSBAA-yyy	SIBAH-yyy	
	095E2B401 BACAA100190		SIBAH-yyy	PBBAA-yyy
MD-410	095E2D400 BACAA100190	PSBAA-yyy	SIBAH-yyy	
	095E2D401 BACAA100190		SIBAH-yyy	PBBAA-yyy
	115E2C300 BACAA115190	PSBAA-yyy	SIBAH-yyy	
	115E2C301 BACAA115190		SIBAH-yyy	PBBAA-yyy
MD-420	115E2E300 BACAA115240	PSBAA-yyy	SIBAH-yyy	
	115E2E301 BACAA115240		SIBAH-yyy	PBBAA-yyy
	142E2D300 BACAA165240	PSBAA-yyy	SIBAH-yyy	
	142E2D301 BACAA165240		SIBAH-yyy	PBBAA-yyy
MD-434	190E2D200 BACAA215320	PSBBK-yyy	SIBAH-yyy	
	190E2D201 BACAA215320		SIBAH-yyy	PBBBK-yyy

MDS

230V NT and MG Motors

The NT is an economical, high performance motor manufactured with powerful Neodymium magnets and a patented segmented core to maximize torque and minimize size. The NT motor has a very low inertia for applications that demand high accel and cycle rates. NT motors can be ordered with MS style connectors, 1 m Flying Leads or 1 m Flying Leads with MS connectors.

The MG Motor is a compact, low inertia motor ideal for dynamic applications needing greater torque than the NT. Both the NT and MG are available with English and Metric flanges, with or without brakes. Both have a standard encoder resolution of 2048 lines per rev.



MDS - 230V NT Motor Specifications

Drive Model	Motor Model	Cont. Stall Torque	Peak Stall Torque	Rated Torque @Rated Speed*	Rated Power HP	Max.* Operating Speed RPM	Encoder Resolution lines/rev	Inertia lb-in-sec ²	Motor Ke Vrms/krpm	Motor Kt lb-in/Arms	Motor Weight lb
		lb-in	lb-in	lb-in	kWatts						
MD-407	NT-320	19.5	38	16	1.02	4000	2048	0.000328	29	3.50	6
		2.2	4.3	1.8	0.8						
MD-407	NT-330	27	58	27	1.71	4000	2048	0.000438	36	4.73	7.3
		3.05	6.55	3.1	1.3						
MD-410	NT-345	42	80	42	2.00	3000	2048	0.000668	50	6.37	10.0
		4.75	9.04	4.75	1.49						
MD-410	NT-355	48	90	48	2.28	3000	2048	0.000888	50	6.32	12.3
		5.42	10.2	5.42	1.71						

MDS - 230V MG Motor Specifications

Drive Model	Motor Model	Cont. Stall Torque	Peak Stall Torque	Rated Torque @Rated Speed*	Rated Power HP	Max.* Operating Speed RPM	Encoder Resolution lines/rev	Inertia lb-in-sec ²	Motor Ke Vrms/krpm	Motor Kt lb-in/Arms	Motor Weight lb
		lb-in	lb-in	lb-in	kWatts						
MD-404	MG-316	18.6	42	16	1.02	4000	2048	0.000560	38	5.5	8.3
		2.1	4.6	1.8	0.8						
MD-407	MG-316	18.6	56	16	1.02	4000	2048	0.000560	38	5.5	8.3
		2.1	6.3	1.8	0.8						
MD-407	MG-340	50	133	42	2.00	3000	2048	0.001458	57	8.3	14.6
		5.7	15.0	4.8	1.5						
MD-410	MG-455	68	154	52	2.48	3000	2048	0.002658	60	8.8	20.0
		7.7	17.5	5.8	1.9						
MD-420	MG-455	68	200	52	2.48	3000	2048	0.002658	60	8.8	20.0
		7.7	22.6	5.8	1.9						
MD-420	MG-490	129	302	80	3.81	3000	2048	0.005175	59	8.6	28.6
		14.57	34.1	9.0	2.8						
MD-420	MG-4120	163	382	120	5.71	3000	2048	0.007458	72	10.5	37.0
		18.4	43.2	13.6	4.3						

* Rated Speed = Maximum Operating Speed

MDS - 230V NT Motor Speed Torque Curves

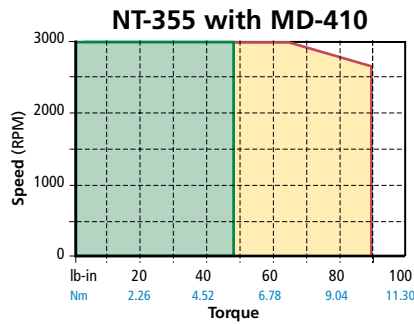
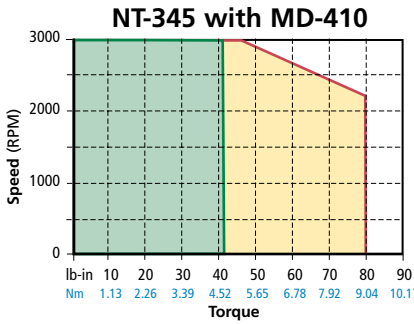
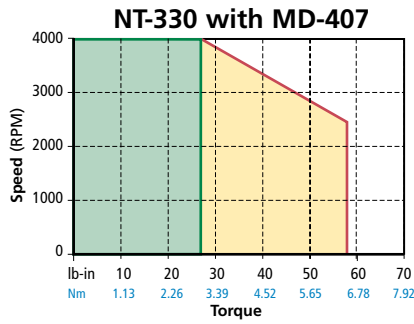
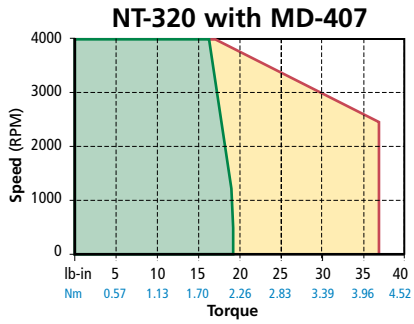

Legend

- Continuous Torque
- Peak Torque

SPECIFICATIONS

Voltage	240 VAC
Drive Frequency	5 kHz
Ambient Temperature	25°C (77°F)
Case Temperature	100°C (212°F)

MDS - 230V MG Motor Speed Torque Curves

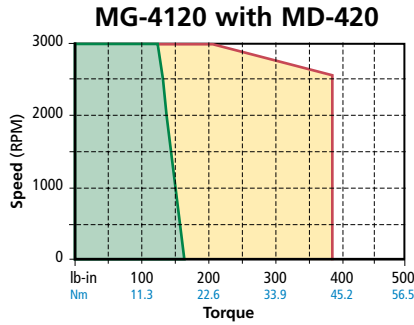
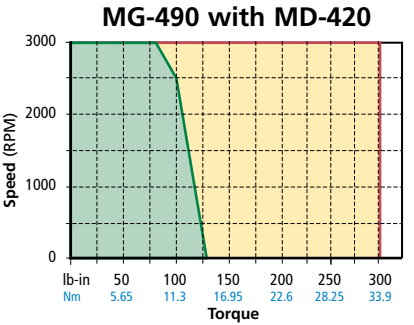
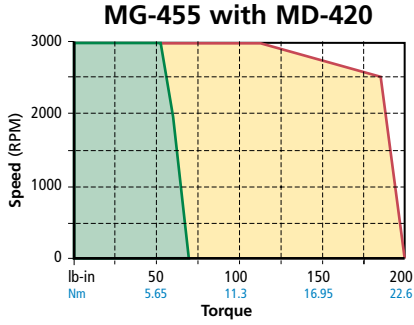
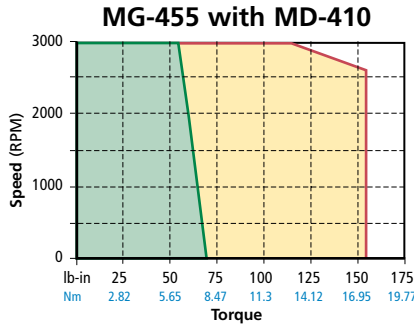
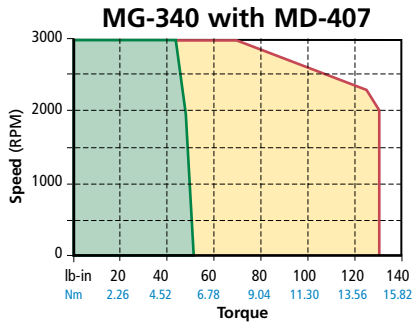
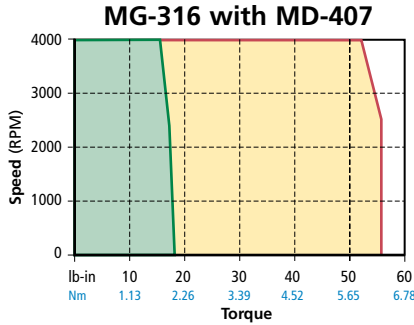
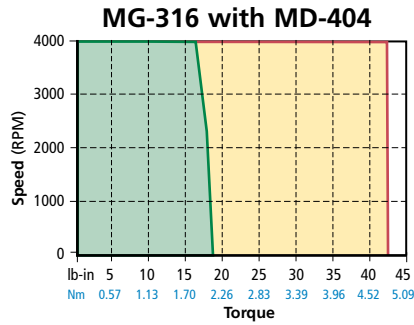

SPECIFICATIONS

All performance data listed above has a +/-10% tolerance and is subject to change at any time without notice. For more detailed information on performance data and test conditions please refer to the motor section of the catalog. For brake motor information, complete motor specifications and dimensions please refer to our motor section.

MDS

230V NT Motor Selection

The NT motor is a high performance motor utilizing patented technology to maximize torque in a compact package. The NT motor uses powerful Neodymium magnets and is manufactured with a segmented core to maximize stator efficiency. The NT motor has a very low inertia for applications that demand high accel and cycle rates. NT motors are available in English (NEMA 23 or 34) or Metric (IEC-72-1) flanges, with or without brakes. The standard encoder resolution is 2048 lines per rev. NT motors can be ordered with MS style connectors, 1 m Flying Leads, or 1 m Flying Leads with MS connectors.

Order String

NT	x	x	xx	x	x	N	S	0000
↑	↑	↑	↑	↑	↑	↑	↑	↑

Special Options: DSXX = DSUB
 Inertia: **S** = Standard, **I** = Medium
 Encoder Feedback Type: **N** = Encoder
 Brake Option: **B** = with Brake, **O** = No Brake
 Connector Type:
C = MS connectors on motor
T = MS connectors on one meter leads
L = one meter leads without connectors
 Continuous Torque (lb-in): **20, 30, 45** or **55**
 Frame Size (in inches): **3**
 Mounting Flange: **E** = English, **M** = Metric
NT Motor Family

For additional motor information see the Servo Motor area in this section for details.
For additional cable options see Options

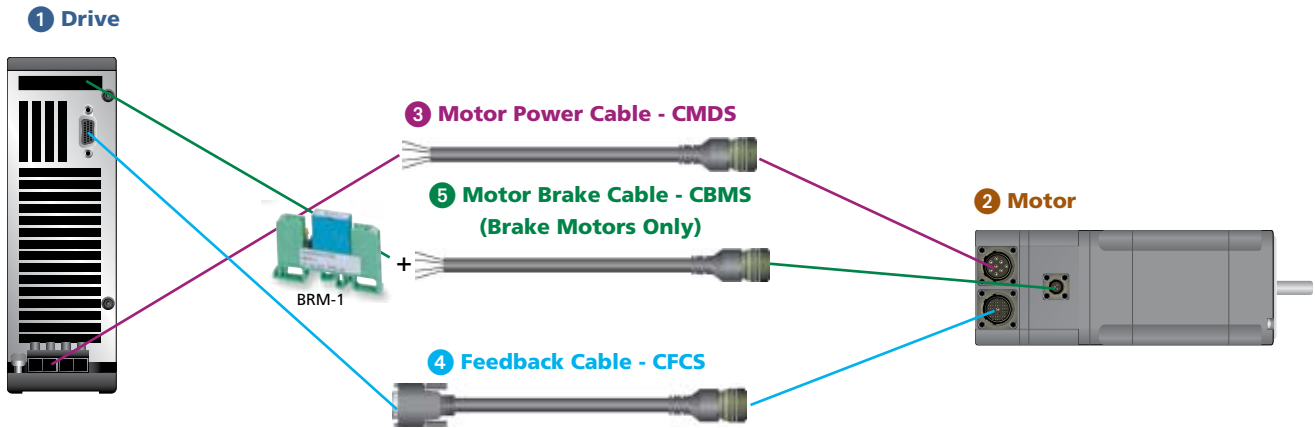

Servo System Order Guide

① Drive Model	② Motor Model (x=Flange type) (y=Connector)	③ Motor Power Cable (xxx=feet)	④ Feedback Cable (xxx=feet)	⑤ Motor Brake Cable (required w/all brake motors) (xxx=feet)
MD-407-00-000	NTx-320-yONS-0000	CMDS-xxx	CFCS-xxx	
	NTx-320-yBNS-0000	CMDS-xxx	CFCS-xxx	CBMS-xxx
	NTx-330-yONS-0000	CMDS-xxx	CFCS-xxx	
	NTx-330-yBNS-0000	CMDS-xxx	CFCS-xxx	CBMS-xxx
MD-410-00-000	NTx-345-yONS-0000	CMDS-xxx	CFCS-xxx	
	NTx-345-yBNS-0000	CMDS-xxx	CFCS-xxx	CBMS-xxx
	NTx-355-yONS-0000	CMDS-xxx	CFCS-xxx	
	NTx-355-yBNS-0000	CMDS-xxx	CFCS-xxx	CBMS-xxx

MDS

230V MG Motor Selection

The MG motor is a low inertia motor that is great for dynamic applications that have larger load inertias. MG motors use Neodymium magnets to achieve a high torque to inertia ratio giving them a size advantage when compared to competitors motors. MG motors are available in English (NEMA 23, 34, or 56) and Metric (IEC-72-1) flanges, with or without brakes. The standard encoder resolution is 2048 lines per rev. MG motors come standard with MS style connectors. For applications that require custom motors the MG line is the choice.

Order String

MG	x	x	xx	C	x	N	S	0000
↑	↑	↑	↑	↑	↑	↑	↑	↑

Special Options

S = Shaft Seal (Standard)

N = Encoder Feedback Type: Encoder

Brake Option: B = with Brake,
O = No Brake

Connector Type:
C = MS connectors on motor

Continuous Torque (lb-in): 16, 40, 55, 90 or 120

Frame Size (in inches): 3 or 4

Mounting Flange: E = English, M = Metric

MG Motor Family

For additional motor information see the Servo Motor area in this section for details.
For additional cable options see Options

MDS Series

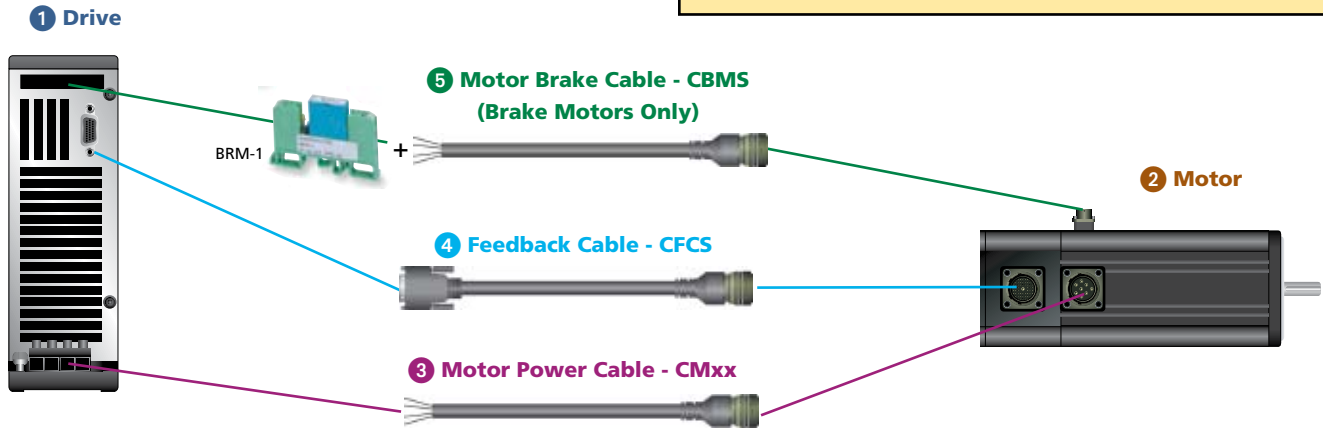

① Drive Model	② Motor Model (x=Flange type)	③ Motor Power Cable (xxx=feet)	④ Feedback Cable (xxx=feet)	⑤ Motor Brake Cable (required w/all brake motors) (xxx=feet)
MD-404-00-000	MGx-316-CONS-0000	CMDS-xxx	CFCS-xxx	
	MGx-316-CBNS-0000	CMDS-xxx	CFCS-xxx	CBMS-xxx
MD-407-00-000	MGx-316-CONS-0000	CMDS-xxx	CFCS-xxx	
	MGx-316-CBNS-0000	CMDS-xxx	CFCS-xxx	CBMS-xxx
	MGx-340-CONS-0000	CMDS-xxx	CFCS-xxx	
	MGx-340-CBNS-0000	CMDS-xxx	CFCS-xxx	CBMS-xxx
MD-410-00-000	MGx-455-CONS-0000	CMMS-xxx	CFCS-xxx	
	MGx-455-CBNS-0000	CMMS-xxx	CFCS-xxx	CBMS-xxx
MD-420-00-000	MGx-455-CONS-0000	CMMS-xxx	CFCS-xxx	
	MGx-455-CBNS-0000	CMMS-xxx	CFCS-xxx	CBMS-xxx
	MGx-490-CONS-0000	CMMS-xxx	CFCS-xxx	
	MGx-490-CBNS-0000	CMMS-xxx	CFCS-xxx	CBMS-xxx
	MGx-4120-CONS-0000	CMMS-xxx	CFCS-xxx	
	MGx-4120-CBNS-0000	CMMS-xxx	CFCS-xxx	CBMS-xxx

MDS

460V FM Motor

MDS Series

The FM 460V line is a medium to high inertia line for larger load applications. It is designed to allow use in many applications and offers a wide range of options. The FM line is offered in metric frame sizes, 75 mm, 95 mm, 115 mm, 142 mm and 190 mm. The standard configured motor has a 4096 line encoder, vertical connectors and non-brake. This configuration is designed with low cogging torque to provide smooth operation and excellent velocity regulation. The torque range available is 38.2 lb-in (4.3 Nm) to 520 lb-in (58.8 Nm). All models are rated IP65.

The FM motor is also available with many other options like resolver and Sin/Cos feedback, NEMA flange, different shaft diameters, 90° and rotatable connectors, and a high peak torque option that allows intermittent operation near 5 times their continuous torque levels.



MDS - 460V FM Motor Specifications

Drive Model	Motor Model	Cont. Stall Torque lb-in Nm	Peak Stall Torque lb-in Nm	Rated Torque @Rated Speed* lb-in Nm	Rated Power HP kWatts	Max.* Operating Speed RPM	Encoder Resolution lines/rev	Inertia lb-in-sec ² kg-cm ²	Motor Ke Vrms/ krpm	Motor Kt lb-in/Arms Nm/Arms	Motor Weight lb kg
MD-404	095U2B400	38.23	84.96	26.55	1.68	4000	4096	0.002567	74	10.62	6.3
		4.32	9.60	3.00	1.26						
MD-404	095U2E400	42.48	84.96	42.48	2.68	4000	4096	0.005487	74	10.62	9.9
		4.80	9.60	4.80	2.01						
MD-407	095U2E400	74.34	148.68	50.45	3.19	4000	4096	0.005487	74	10.62	9.9
		8.40	16.80	5.70	2.39						
MD-407	115U2C300	83.54	198.24	71.68	3.39	3000	4096	0.007965	98	14.16	11.6
		9.44	22.40	8.10	2.54						
MD-410	115U2E300	135.94	283.20	111.51	5.28	3000	4096	0.012213	98	14.16	15.4
		15.36	32.00	12.60	3.96						
MD-407	142U2C300	99.12	198.24	99.12	4.69	3000	4096	0.019647	98	14.16	35.4
		11.20	22.40	11.20	3.52						
MD-410	142U2C300	135.94	283.20	107.97	5.11	3000	4096	0.019647	98	14.16	35.4
		15.36	32.00	12.20	3.83						
MD-410	142U2E300	141.60	283.20	141.60	6.71	3000	4096	0.031329	98	14.16	47.7
		16.00	32.00	16.00	5.03						
MD-420	142U2E300	208.15	566.40	159.30	7.53	3000	4096	0.031329	98	14.16	47.7
		23.52	64.00	18.00	5.65						
MD-420	190U2D300	283.20	566.40	283.20	13.40	3000	4096	0.076464	98	14.16	74.6
		32.00	64.00	32.00	10.05						
MD-434	190U2D300	363.91	962.88	283.20	13.81	3000	4096	0.076464	98	14.16	74.6
		41.12	108.80	32.00	10.36						
MD-434	190U2F200	520.38	1444.32	446.04	14.07	2000	4096	0.108944	147	21.24	93.5
		58.80	163.20	50.40	10.55						

*Rated Speed = Maximum Operating Speed

MDS - 460V FM Motor Speed Torque Curves

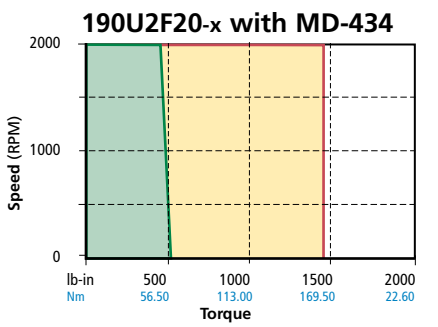
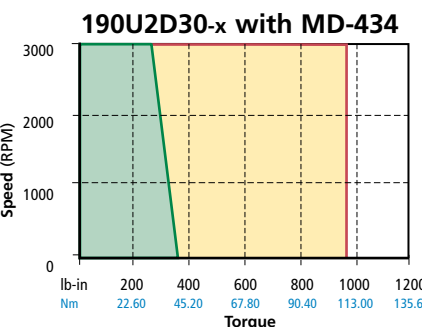
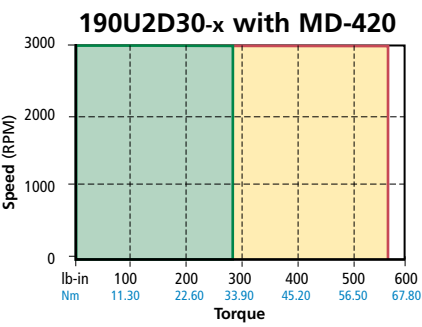
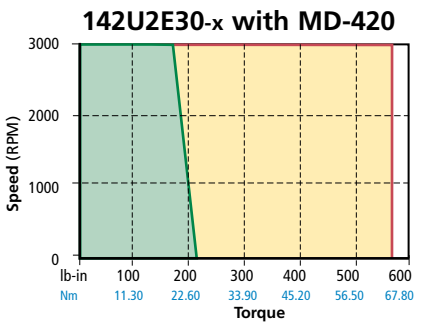
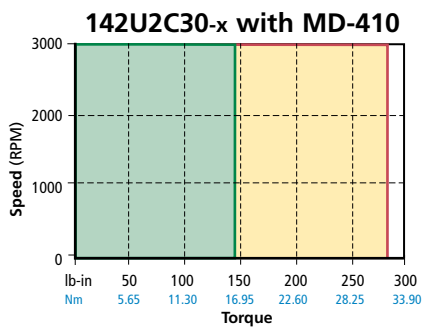
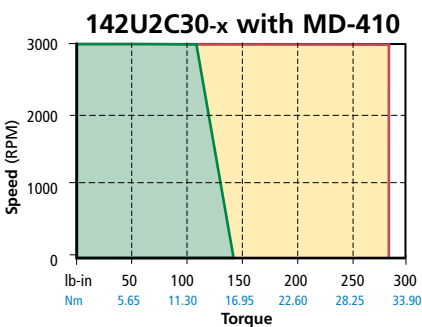
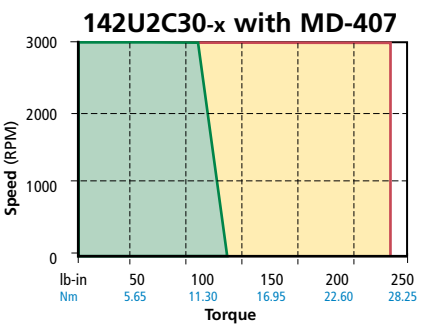
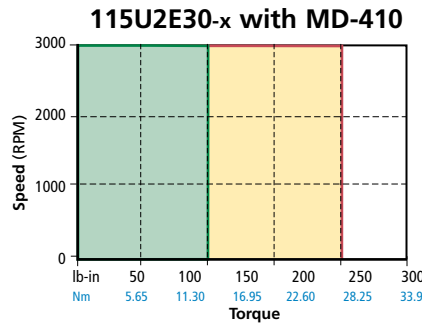
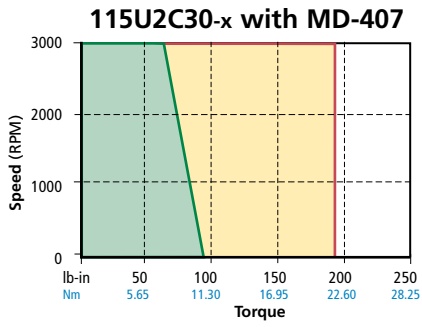
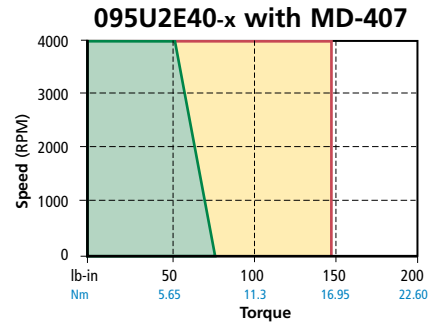
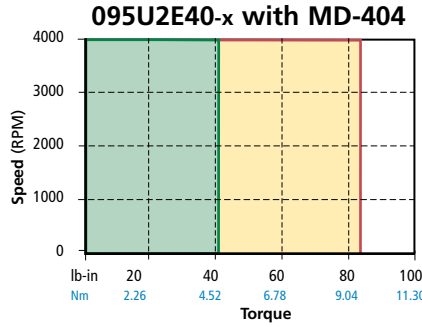
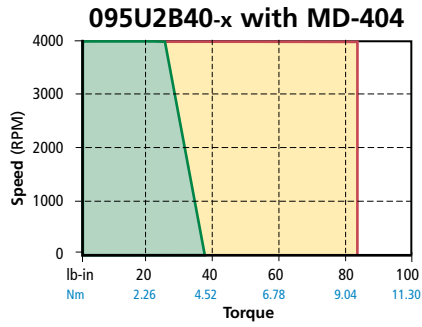

Legend
 Continuous Torque
 Peak Torque

SPECIFICATIONS	
Voltage	480 VAC
Drive Frequency	5 kHz
Ambient Temperature	40°C (104°F)
Case Temperature	140°C (284°F)

All performance data listed above has a +/-10% tolerance and is subject to change at any time without notice. For more detailed information on performance data and test conditions please refer to the motor section of the catalog. For brake motor information, complete motor specifications and dimensions please refer to our motor section.

MDS

460V MH Motor

The MH Motor is a low inertia motor that is ideally suited to the MDS operating with 460 VAC Input. Applications with torque requirements between 21.5 lb-in (2.4 Nm) and 748 lb-in (84.5 Nm) can be solved. MH motors use Neodymium magnets to achieve a high torque to inertia ratio giving them a size advantage when compared to competitors' motors. MH motors are available in English and Metric flanges, with or without brakes. The standard encoder resolution is 2048 lines per rev. For applications that require custom motors the MH line is the choice.



MDS - 460V MH Motor Specifications

Drive Model	Motor Model**	Cont. Stall Torque lb-in Nm	Peak Stall Torque lb-in Nm	Rated Torque @Rated Speed* lb-in Nm	Rated Power HP kWatts	Max.* Operating Speed RPM	Encoder Resolution lines/rev	Inertia lb-in-sec ² kg-cm ²	Motor Ke Vrms/krpm	Motor Kt lb-in/Arms Nm/Arms	Motor Weight lb kg
MD-404	MH-316	21.5 2.4	58 6.6	17.5 2	1.11 0.83	4000	2048	0.000673 0.8	75	10.98 1.24	8.3 3.8
MD-404	MH-340	46 5.2	135 15.3	37 4.2	1.76 1.31	3000	2048	0.001428 1.6	116	16.98 1.92	12.4 5.6
MD-404	MH-455	65 7.3	131 14.8	50.6 5.7	2.41 1.8	3000	2048	0.003557 4	120	17.57 1.99	18 8.2
MD-407	MH-455	72.5 8.2	210 23.7	50.6 5.7	2.41 1.8	3000	2048	0.003557 4	120	17.57 1.99	18 8.2
MD-407	MH-490	105 11.9	210 23.7	50 5.7	2.38 1.78	3000	2048	0.006727 7.6	110	16.10 1.82	26.2 11.9
MD-410	MH-490	105 11.9	300 33.9	50 5.7	2.38 1.78	3000	2048	0.006727 7.6	110	16.10 1.82	26.2 11.9
MD-410	MH-6120	119 13.4	336.8 38.1	91.4 10.3	4.35 3.25	3000	2048	0.010657 12	115	16.84 1.9	32.4 14.7
MD-420	MH-6200	234 26.4	673.6 76.1	95.9 10.8	4.57 3.41	3000	2048	0.018857 21.3	115	16.84 1.9	48 21.8
MD-420	MH-6300	299 33.8	673.6 76.1	105.4 11.9	5.02 3.74	3000	2048	0.027187 30.7	115	16.84 1.9	65 29.5
MD-420	MH-8250	285 32.2	607 68.6	210 23.7	10 7.45	3000	2048	0.059 61.4	128	18.70 2.11	77 35
MD-434	MH-8500	530 60.2	997 113.2	280 31.8	13.34 9.95	3000	2048	0.078 87.8	121.6	17.80 2.01	110 49.9
MD-434	MH-8750	748 84.5	1500 170.3	485 54.8	19.24 14.35	2500	2048	0.133 150	162	23.70 2.68	171 77.6

* Rated Speed = Maximum Operating Speed

**See the complete order string in the Servo motor section of this catalog.

MDS - 460V MH Motor Speed Torque Curves

MDS Series

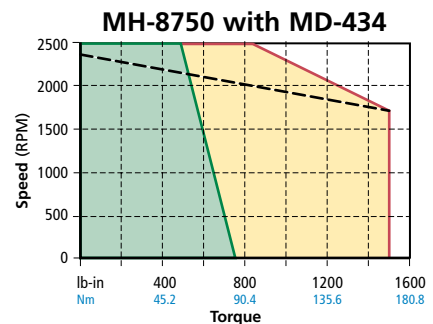
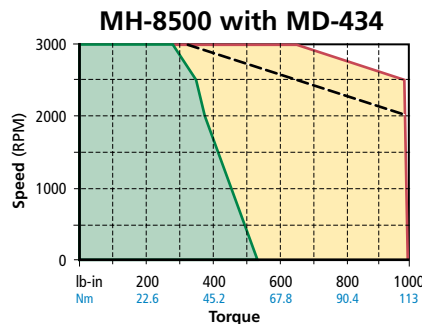
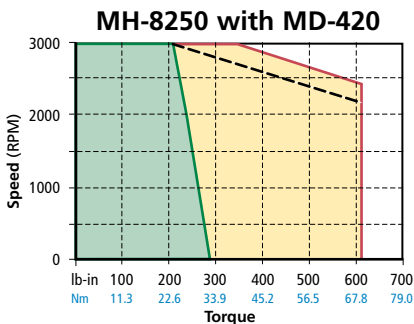
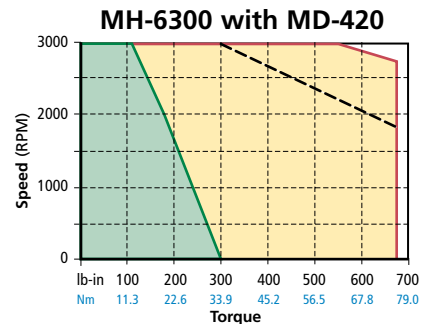
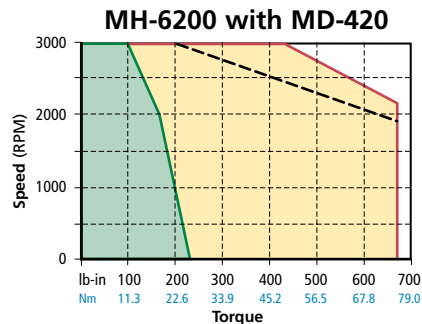
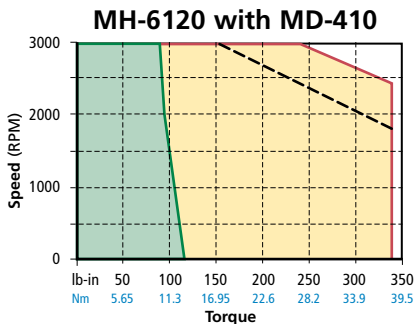
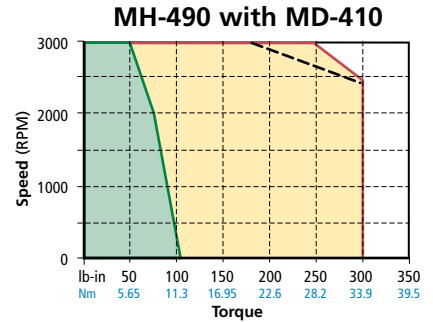
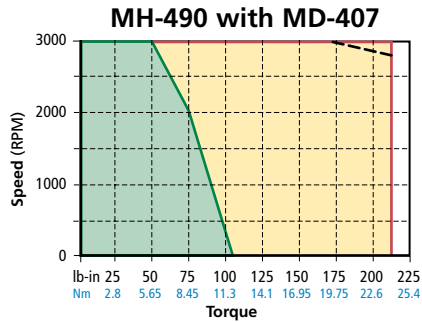
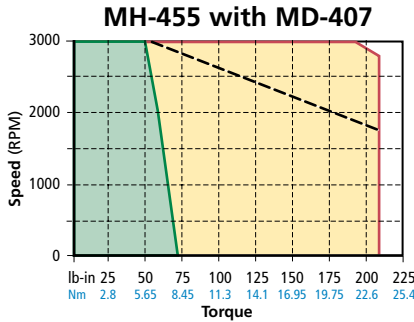
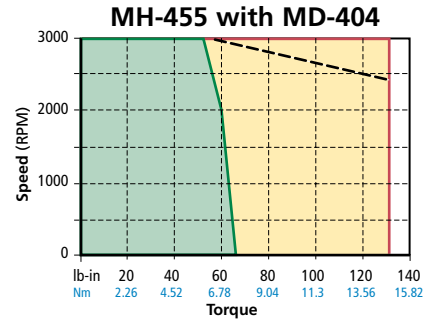
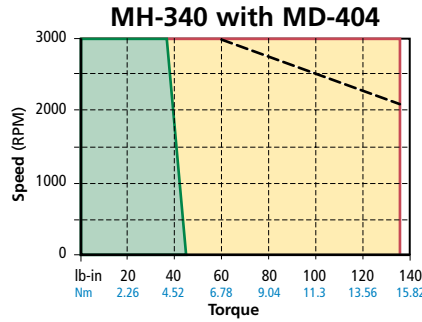
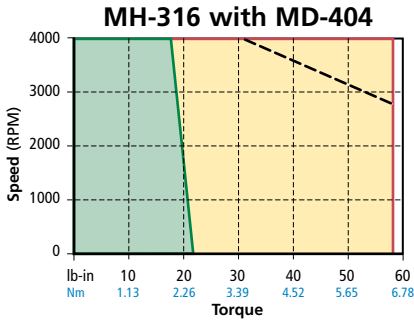

- Legend**
- - - 380V Curve
 - Continuous Torque
 - Peak Torque

SPECIFICATIONS

Voltage 480 VAC
 Drive Frequency 5 kHz
 Ambient Temperature 25°C (77°F)
 Case Temperature 100°C (212°F)

All performance data listed above has a +/-10% tolerance and is subject to change at any time without notice. For more detailed information on performance data and test conditions please refer to the motor section of the catalog. For brake motor information, complete motor specifications and dimensions please refer to our motor section.

MDS

460V MH Motor Selection

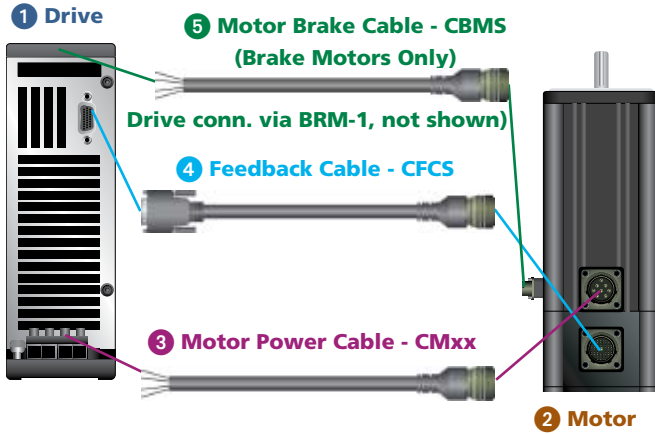

Order String

MH	X	X	XX	C	X	N	S	0000
↑	↑	↑	↑	↑	↑	↑	↑	↑

Special Options
S = Shaft Seal (Standard)
N = Feedback Type: Encoder

Brake Option:
B = with brake
O = without brake

Connector Type:
C = MS connectors on motor

Continuous Torque (lb - in): **16, 40, 55, 90, 120, 200, 250, 300, 500, or 750**

Frame Size (in inches): **3, 4, 6 or 8**

Mounting Flange: E = English, M = Metric

MH Motor Family

MDS Series

Servo System Order Guide

① Drive Model	② Motor Model (x=flange type)	③ Motor Power Cable (xxx=feet)	④ Feedback Cable (xxx=feet)	⑤ Motor Brake Cable (required w/all brake motors) (xxx=feet)
MD-404-00-000	MHx-316-CONS-0000	CMDS-xxx	CFCS-xxx	
	MHx-316-CBNS-0000	CMDS-xxx	CFCS-xxx	CBMS-xxx
	MHx-340-CONS-0000	CMDS-xxx	CFCS-xxx	
	MHx-340-CBNS-0000	CMDS-xxx	CFCS-xxx	CBMS-xxx
	MHx-455-CONS-0000	CMMS-xxx	CFCS-xxx	
	MHx-455-CBNS-0000	CMMS-xxx	CFCS-xxx	CBMS-xxx
MD-407-00-000	MHx-455-CONS-0000	CMMS-xxx	CFCS-xxx	
	MHx-455-CBNS-0000	CMMS-xxx	CFCS-xxx	CBMS-xxx
	MHx-490-CONS-0000	CMMS-xxx	CFCS-xxx	
	MHx-490-CBNS-0000	CMMS-xxx	CFCS-xxx	CBMS-xxx
MD-410-00-000	MHx-490-CONS-0000	CMMS-xxx	CFCS-xxx	
	MHx-490-CBNS-0000	CMMS-xxx	CFCS-xxx	CBMS-xxx
	MHM-6120-CONS-0000	CMMS-xxx	CFCS-xxx	
	MHM-6120-CBNS-0000	CMMS-xxx	CFCS-xxx	CBMS-xxx
MD-420-00-000	MHM-6200-CONS-0000	CMMS-xxx	CFCS-xxx	
	MHM-6200-CBNS-0000	CMMS-xxx	CFCS-xxx	CBMS-xxx
	MHM-6300-CONS-0000	CMMS-xxx	CFCS-xxx	
	MHM-6300-CBNS-0000	CMMS-xxx	CFCS-xxx	CBMS-xxx
	MHM-8250-CONS-0000	CMLS-xxx	CFCS-xxx	
	MHM-8250-CBNS-0000	CMLS-xxx	CFCS-xxx	CBMS-xxx
MD-434-00-000	MHM-8500-CONS-0000	CMLS-xxx	CFCS-xxx	
	MHM-8500-CBNS-0000	CMLS-xxx	CFCS-xxx	CBMS-xxx
	MHM-8750-CONS-0000	CMLS-xxx	CFCS-xxx	
	MHM-8750-CBNS-0000	CMLS-xxx	CFCS-xxx	CBMS-xxx